

Dehumidifier Instruction Manual



CRYSTAL 25L WiFi



Please keep this instruction manual for future potential usage.

Contents

Please take some time to read this instruction manual and keep it for potential usage.

	Page
Warnings-----	1
Working principle-----	2
Working environment-----	3
Important Safety Measures-----	4
Body of machine-----	5
Operation Method-----	6-9
Drainage-----	10-11
Wi-Fi instructions-----	12-17
Maintenance-----	18
Storage-----	19
Problem shooting-----	20-21
Safety Instructions-----	22-25
Appendix-----	26-32

Warnings

This appliance can be used by children aged from 8 years and above and persons with reduced physical, sensory or mental capabilities or lack of experience and knowledge if they have been given supervision or instruction concerning use of the appliance in a safe way and understand the hazards involved. Children shall not play with the appliance. Cleaning and user maintenance shall not be made by children without supervision.

If the supply cord is damaged, it must be replaced by the manufacturer, its service agent or similarly qualified persons in order to avoid a hazard.

Meaning of crossed –out wheeled dustbin:

Do not dispose of electrical appliances as unsorted municipal waste, use separate collection facilities.

Contact your local government for information regarding the collection systems available.

If electrical appliances are disposed of in landfills or dumps, hazardous substances can leak into the groundwater and get into the food chain, damaging your health and well-being.

When replacing old appliances with new ones, the retailer is legally obligated to take back your old appliance for disposals at least free of charge.



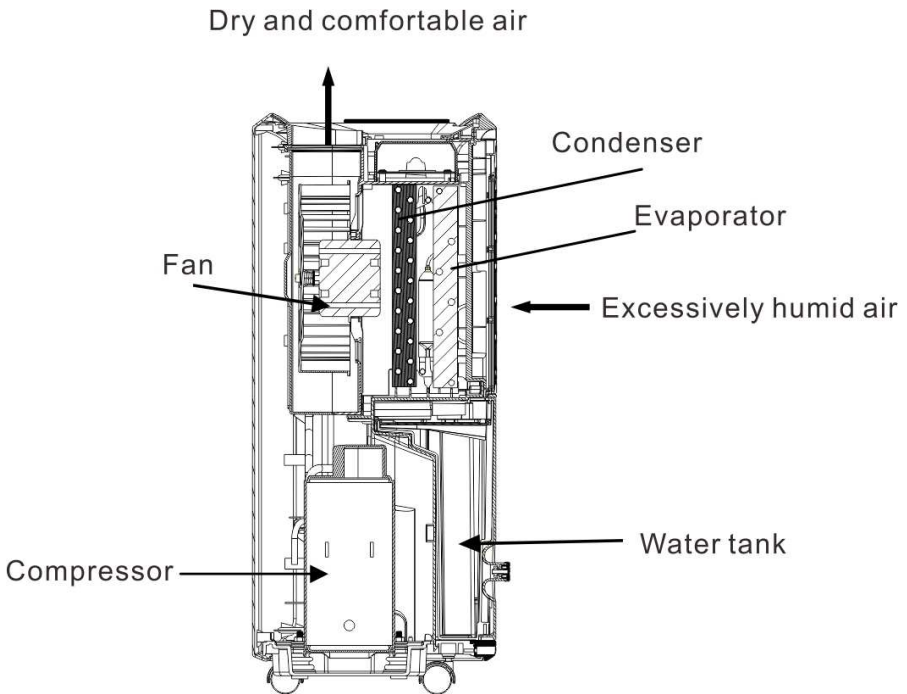

Working Principle

This product has passed the relevant safety certification. It is a mobile dehumidifier that integrates functions such as dehumidification and drying. It can set the target humidity according to different needs of individuals, so that humid air continuously flows through the evaporator and condenser. During the whole process, the excessively humid air first passes through the evaporator, and the water in the air is condensed by the evaporator into water droplets and collected in the water tank. Then the air is dried by the condenser and then sent back to the room, so that the circulation is repeated to reduce the room humidity.

Working environment

This is a mobile intelligent dehumidifier, and you can set the room humidity according to your requirement. It could create a healthy and comfortable environment. The machine usually used in basement, wine cellar, storage, closet. It also could be used in kitchen, library, showroom, computer room, archives, living room and bedroom.

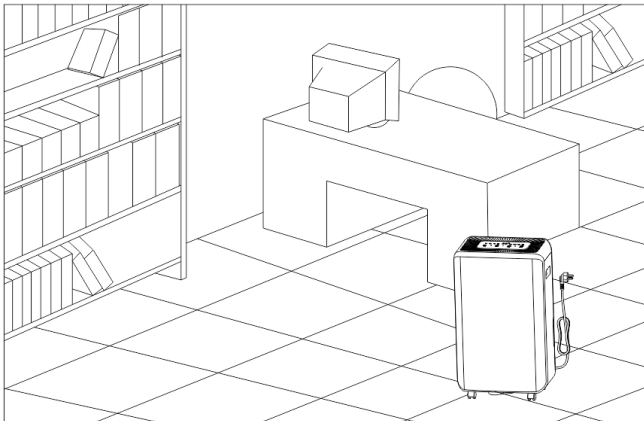
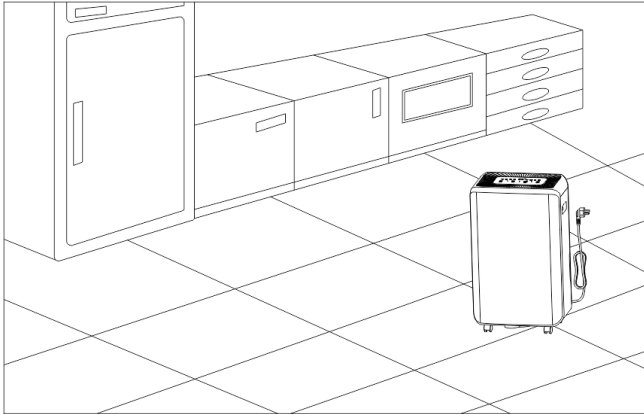

Important Safety Measures

1. Keep the machine upright on the floor.
2. After be transported or tilted (caused by cleaning), the machine need to be stopped for an hour and then you can plugged it into power.
3. Make sure there's 25CM distance around the machine.
4. Keep the outside object away from air inlet and outlet.
5. Don't pour or splash water onto the machine.
6. The power supply must be accorded with the description in rating label.
7. Don't plug/unplug the machine to open/close it and use the control panel.
8. Before moving the machine, you need to turn off it, unplug and ensure the water tank is empty.
9. If the filter is dirty, it is better to clean it. When the filter is clean, the machine works better.
10. Don't use bad quality or flammable cleaner to clean the machine.
11. When there's something wrong with the machine, turn off the machine, unplug it.
12. When the wire is broken, you need to find a recognized comprehensive office or qualified person to replace it in order to prevent the danger.

Body of Machine

1. Pull-up Handle
2. Control Panel
3. Air Outlet
4. Castor
5. Humidity sensing port
6. Frame of Filter
7. Air Inlet
8. Continuous drainage hole
9. Winding plate
10. Power wire
11. Water Tank
12. Handle of water tank

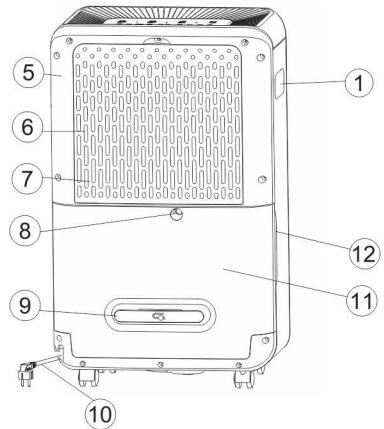
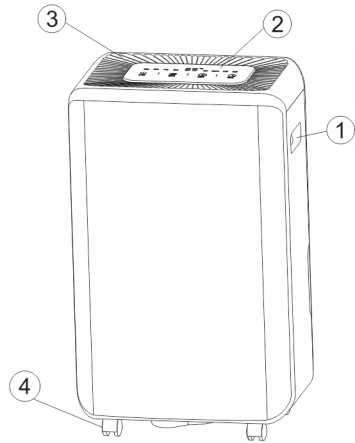

Operation Method

● Operation Panel Icon

Graphical illustration of the operation panel (the color of the sticker is subject to the actual product)

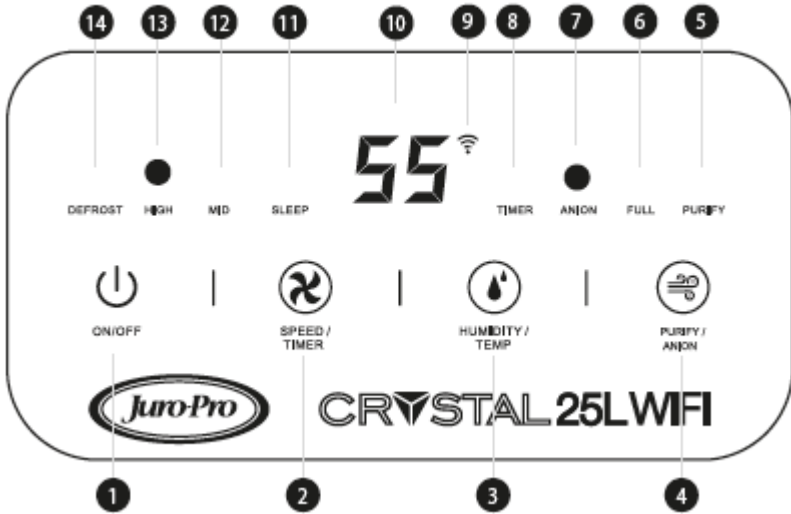

1. ON/OFF(ON/OFF)
2. Speed/Timer button(Speed/Time)
3. Humidity setting/temperature display button(Humidity/Temp)
4. Purifying/Anion button(Purify/Anion)
5. Purifying indicator(Purify)
6. Water full indicator(Tank full)
7. Anion indicator(Anion)
8. Timing setting indicator(Time)
9. Wi-Fi indicator
10. Digital display
11. Low speed indicator(Low)
12. Middle speed indicator(Mid)
13. High speed indicator(High)
14. Defrost indicator(Defrost)

- Operation Instruction

- ◆ ON/OFF

1. Connect the power and make a “beep” sound (refer to the power supply parameters on the nameplate to access the power supply).
2. Press the “ON/OFF” button to turn it on. After the power is turned on, the corresponding indicator lights up to display the system default working mode.
3. Press the “ON/OFF” button in the power-on state to turn off the power, and all the indicators are off (if the water is full, the water full indicator will still light even if the power is off) . If you are not using the machine for a long time, it is recommended to unplug the power cord from the outlet.

- ◆ Timing function

1. In the power on state, press the “speed/timer” for a long time to set the timing, display the current timing time. Press the “speed” repeatedly to set the automatic shutdown. The setting time range is 0-24 hours (0 represents untimely). After the nixie tube stops pressing for 5 seconds, the display environment humidity will be restored, and the timing indicator light will be on. Once the setting time is up, the machine will shut down automatically.

2. In the shutdown state, long press the “speed/timer” key to set the timing, display the current timing time, and repeatedly press the ”speed” to set the automatic start-up. The setting process is the same as setting the timing shutdown. After the timing function is started, the timing shutdown. After the timing function is started, the timing indicator lights up, and the digital tube displays the set time, and uses 1 hour is the unit decline. Once the set time is up, the machine will start automatically (if the water is full, it will not start even when the time is up).

- ◆ Humidity setting

1. Press the “humidity/temp” button to select the target humidity. Each time you press “humidity” button to select different target humidity, the humidity selection gear has (RH) 40%, 45%, 50%, 55%, 60%, 65%, 70%,

75%, 80% and “CO” have a total of 10 files. After selecting the target humidity, the display will flash several times to automatically confirm the selected humidity, and then restore the display environment humidity. When the target humidity is at “CO”, the machine remains dehumidified regardless of the ambient humidity.

Note: Humidity can only be set in dehumidification mode.

◆ Temperature and humidity display

1. After starting the machine without any operation or stopping the operation for 5 seconds, the display screen shows the ambient humidity, the humidity display range is RH20%~95%, when the ambient humidity is $\leq 20\%$, when the ambient humidity is $\geq 95\%$, it shows 95% .

2. Press the key continuously for more than 3 seconds the display screen will display the ambient temperature around the machine, and the display screen will resume to display the ambient humidity after 5 seconds of stopping the operation. Temperature display range is 0-75°C, LO is displayed when temperature is lower than 0°C. HI is displayed when temperature is higher than 75°C.

◆ Wind speed selection

In the power on state, press the “speed/timer” to switch between high, low and middle modes, and the corresponding indicator lights will be on.

◆ Defrost function

This machine has automatic defrosting function. When the machine is working, it will automatically detect and judge whether defrosting is needed. This ensures that the machine still has good dehumidification performance when the ambient temperature is low. During defrost the “Defrost” indicator lights up, the compressor stops working, the fan runs at high speed, and after defrost is finished, the machine automatically returns to the state before defrost.

◆ Water full automatic protection

When the water tank is full of water, the compressor stops working.

After waiting for 3 minutes, the fan stops working. The buzzer sounds 10 times (about 5 seconds) and the “full” indicator lights up. The machine stops dehumidification and waits for water to be poured.

◆ Anion function

The effect of anion is it can purify the air. Long pressing the “Purifying/Anion” button can open or close the anion.

◆ Switching to air purification mode

Press the purifying button and then you can change the dehumidifier from dehumidification to air purification or change from air purification to dehumidification. When in air purification mode, the purifying indicator light lights and the compressor stops working. If it is in the air purification state, pressing the humidity regulating key will not work at this time.

◆ Compressor shutdown/start protection

During operation of the machine, any operation causes the compressor to stop working. At this point, the machine automatically switches to the protection function that the compressor stops for 3 minutes and then starts, that is, the compressor must not be started again within 3 minutes, and other functions have output.

◆ Fault protection identification code

Coil temperature sensor failure: When the coil temperature sensor is detected to be faulty, the display screen is displayed for 1 second “E1” at intervals of 10 seconds. The machine starts to defrost every 30 minutes. After the sensor returns to normal, the machine works normally.

Humidity sensor failure: When the humidity sensor is detected, the display screen is displayed for 1 second “E1” at intervals of 10 seconds. The machine starts to defrost every 30 minutes. After the sensor returns to normal, the machine works normally.

Drainage

When the water in the water tank is full, the water full indicator lights up, the machine beeps and automatically stops. At this time, the water machine in the water tank needs to be drained to work:

1. Grasp the handle of the water tank and gently pull the water tank out to easily remove the water tank. Fig. 1
2. After pouring the water, put the water tank back into the body, and the machine resumes work. If the water tank is not in place, the full water indicator will still light up and the machine will not work.
3. When removing and placing the water tank, take it with care.

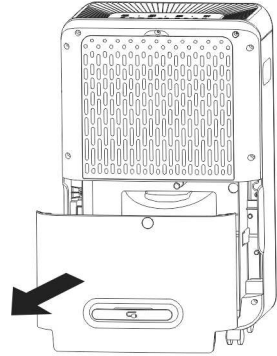

Fig. 1

Continuous Drainage

If the machine is going to run for a long time, please refer to the following steps to drain;

1. Remove the water tank from the back of the machine. Fig. 1
2. Remove the water plug from the continuous drain hole at the back of the machine (Fig. 2)
3. Insert a water pipe with an inner diameter of 12 mm into the continuous drainage hole. The water pipe should have a downward slope and the water outlet should face downward to ensure the smooth discharge of the condensate (Fig. 3).

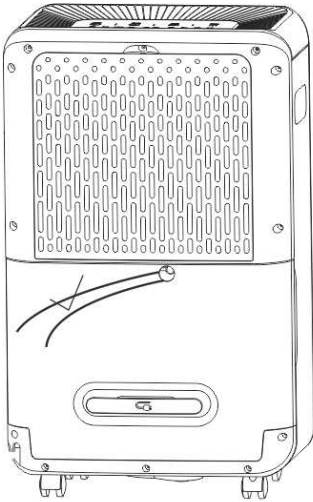

Fig. 2

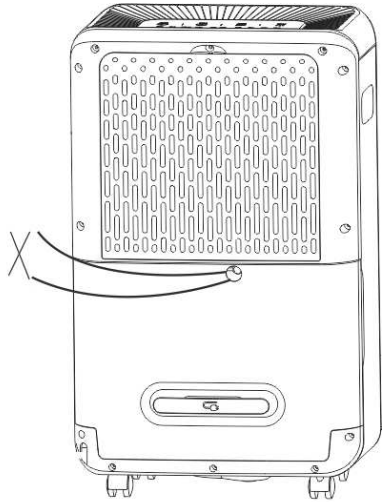
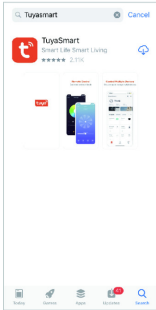

Fig. 3

Wi-Fi instructions

Downloaded the app

Make sure that your mobile phone is connected to your home WiFi. And download the TuyaSmart from the App Store.



1. Manually add

Manually add mode is divided into EZ mode and AP mode :

(1) EZ Mode

1. Open the app. The following interface will appear after you register an account. And click Add Device.

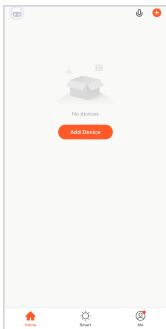

2. Select Add Manually, Small Home Appliance, and Dehumidifier to enter the following interface.



3. Enter your wifi password, click next.

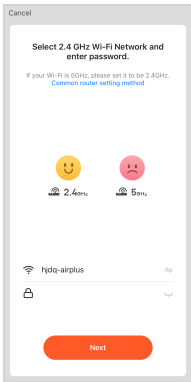

4. Select “Confirm indicator rapidly blink”, click “next”. Then waiting for connecting

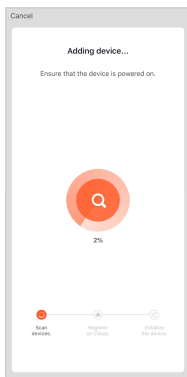
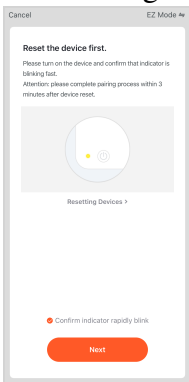

5. Congratulations, you can control the dehumidifier using your mobile phone anytime at anywhere.

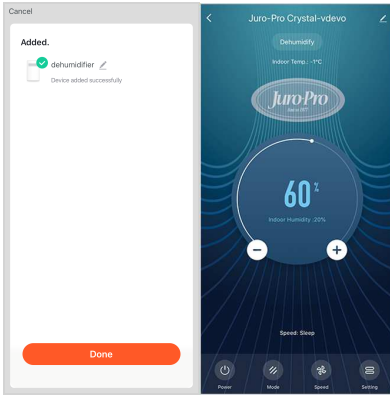

(2) AP Mode

1. Open the app. The following interface will appear after you register an account. And click Add Device.

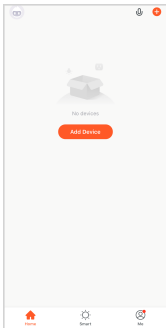

2. Select Add Manually, Small Home Appliance, and Dehumidifier to enter the following interface.

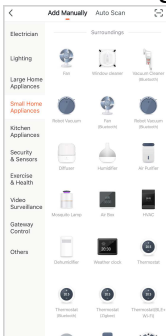

3. Enter your wifi password, click next.

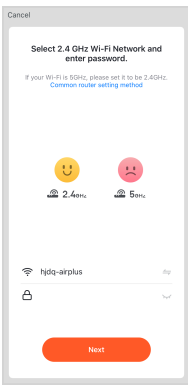

4. Press the “ON/OFF” for seconds to make the WIFI indicator slowly blink. Click EZ mode

In the upper right corner to switch the distribution network mode to AP compatible mode, check “Confirm indicator slowly blink”, then click next.

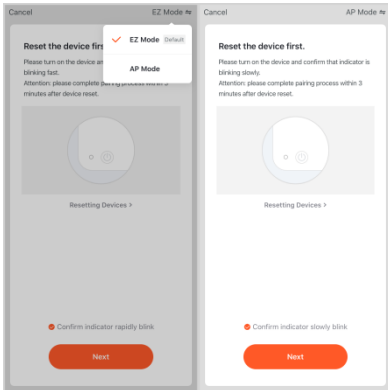

5. Connect the network SmartLife-XXXX, return to APP after successful connection, and connect the network automatically.

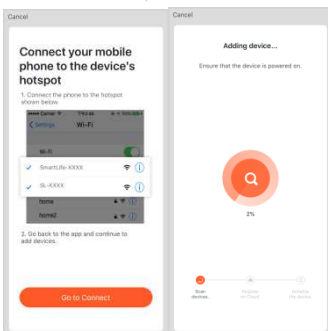

6. Congratulations, you can control the dehumidifier using your mobile using your mobile phone anytime at anywhere.

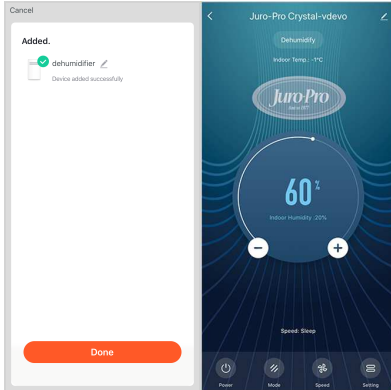

2. Add automatically

1. Open the app. The following interface will appear after you register an account. And click Add Device.

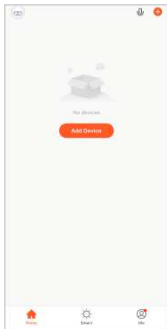

2. Select auto scan to connect the network automatically after the machine is powered on.

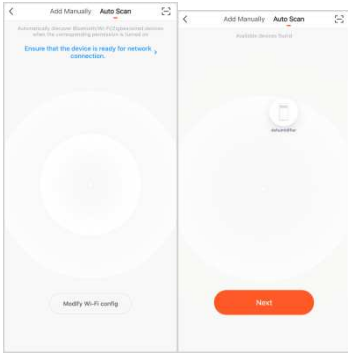

3. Click the next after successful connection, then you can control the dehumidifier using your mobile phone anytime at anywhere.

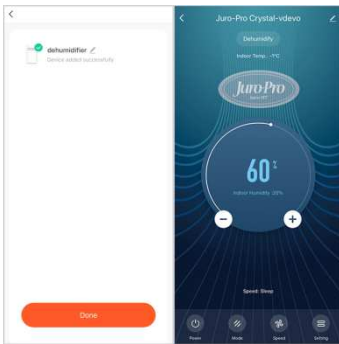

In case of APP problems, long press switch and wind speed buttons to unbind and repeat the connection process.

Maintenance

Pull off power plug from socket before maintaining or washing.

◆ Cleaning

1. Clean the body, please do it 1 hour after the machine stops working.
2. Wipe the machine casing with a soft wet cotton cloth, then dry the machine with a dry cloth.
3. Do not use volatile chemicals, benzene, detergents, chemically processed fabrics or other cleaning solutions to clean the body at any time, which may damage the body.

Note: Do not rinse directly with water during cleaning to avoid machine failure inside the machine.

◆ Cleaning air filter

The dehumidifier is equipped with an initial filter net and an activated carbon filter net, wherein the activated carbon filter net is an optional accessory, which is subject to the actual machine.

◆ Cleaning filter

1. Remove the filter from the back of the machine (fig. 4)

2. Use a portable vacuum cleaner or gently shake the filter to remove dust. If the filter is too dirty, clean the primary filter with warm water with moderate force (fig. 5)

(1) Make sure the filter is completely dry before it can be placed back in the fixture.

(2) Do not expose the filter to sunlight.

(3) Active carbon filter cannot be washed with water, If it is dirty, use a vacuum cleaner or gently pat the dust.

3. It is recommended to replace the activated carbon filter every 6 months, depending on the specific use environment.

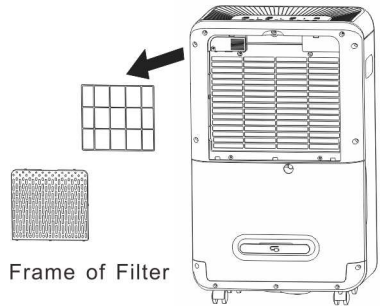

Fig. 4

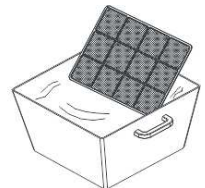

Fig. 5

Machine repair

1. When the product needs to be repaired, please consult the service provider and professional staff. If the self-maintenance causes damage to the body and all accidents, the user is responsible for it.
2. Dispose of the waste that was replaced during the maintenance of the machine.
3. When the service life of the product expires and needs to be disposed of, please send it to the environmental protection professional manufacturer, and do not discard it.

Storage

When machine does not run for long time, please do as follows:

1. Turn off machine, cut off power and sort out power cord.
2. Pour out tank water and wipe it.
3. Clean the filter.
4. Put the machine away, pack the machine in a cardboard box to prevent accumulation of dust, then keep the machine upright and store it in a cool, dry place.

Problem Shooting

Before calling for service, please make following check:

Problems	Possible causes
Machine does not work	<ul style="list-style-type: none"> ● Whether plug is in the power? ● Whether electrical wires indoor in the power? ● Whether full water indicator is lit? (If lit, water tank is possibly full of water or not placed in correct position) ● Whether humidity indoor is lower than the settled target?
Machine does not remove moisture	<ul style="list-style-type: none"> ● Whether the filter is dusty or is contaminated? ● Whether inlet or outlet is blocked? ● Whether humidity indoor is too less?
Dehumidification effect is not obvious	<ul style="list-style-type: none"> ● Whether opening too many windows or doors? ● Whether there are machines indoor making much humidity?
Leaves seems unworking (no air out)	<ul style="list-style-type: none"> ● Whether the filter is clogged? ● Whether the fan is clogged?
Much noise	<ul style="list-style-type: none"> ● Whether the vibration caused by uneven placement of the machine? ● Whether the machine is not even on uneven floor?

If the above situation occurs, the corresponding processing steps cannot be solved, or other reasons occur, please contact the supplier or the repair station, do not disassemble or repair it yourself to avoid accidents.

Problem Shooting

The following symptoms are not failure:

Symptoms	Causes
Noise gets bigger when machine starts	When compressor starts, noise of compressing gets bigger.
Machine will pump out musty taste in first use	Temperature of heat exchanger rises suddenly, leading to temporary strange smell or musty taste.
Machine echoes	If machine used in a small room, or a wooden floor room, may echo.
At the start of operation mode or switched to this mode, machine will make abnormal noise	Refrigerant before restoring stability flow may noise.
Water spots in water tank	These are left traces of water evaporation after factory dehumidification test.

Safety Instructions

Warning

- Do not use means to accelerate the defrosting process or to clean, other than those recommended by the manufacturer.
- The appliance shall be stored in a room without continuously operating ignition sources (for example: open flames, an operating gas appliance or an operating electric heater.)
- Do not pierce or burn.
- Be aware that refrigerants may not contain an odor.
- Appliance shall be installed, operated and stored in a room with a floor area larger than 12.5 m².
- Keep any required ventilation openings clear of obstruction.
- Servicing shall be performed only as recommended by the manufacturer.
- The appliance shall be stored in a well-ventilated area where the room size corresponds to the room area as specified for operation.
- Any person who is involved with working on or breaking into a refrigerant circuit should hold a current valid certificate from an industry-accredited assessment authority, which authorizes their competence to handle refrigerants safely in accordance with an industry, recognized assessment specification.
- Servicing shall only be performed as recommended by the equipment manufacturer. Maintenance and repair requiring the assistance of other skilled personnel shall be carried out under the supervision of the person competent in the use of flammable refrigerants.
- All working procedure that affects safety means shall only be carried by competent persons.
- Be careful not to bump when moving to avoid leakage in the refrigeration line.



Flammable material.



Refer operators



Read technical



Read operators

**This appliance contains R290/
Propane a flammable refrigerant**

manual

manual

The maximum dosage of refrigerant is 90g

Notes:

- The dehumidifier is only suitable for indoor use, and is not suitable for other applications.
- Place the machine in a flat and dry place and keep a distance of above 50cm between the machine and the surrounding objects or walls.
- After the dehumidifier is installed, ensure that the power plug is intact and firmly plugged into the power outlet, and place the power cord orderly to prevent someone from being tripped or pulling out the plug.
- Do not put any object into the air inlet and outlet of the dehumidifier. Keep the air inlet and outlet free from obstructions.
- When drainage pipes are installed, ensure that the drainage pipes are properly connected, and are not distorted or bended.
- When moving the machine, make sure that it is in an upright position.
- The machine should stay away from gasoline, flammable gas, stoves and other heat sources.
- Don't disassemble, overhaul and modify the machine arbitrarily, otherwise it will cause a machine malfunction or even bring harm to persons and properties. To avoid danger, if a machine failure occurs, ask the manufacturer or professionals to repair it.
- Do not pull the plug to turn off the machine.
- Do not place cups or other objects on the body to prevent water or other liquids from spilling into the dehumidifier.
- Do not use insecticide sprays or other flammable substances near the dehumidifier.
- Do not wipe or wash the dehumidifier with chemical solvents such as gasoline and alcohol. When you need to clean the air conditioning, you must disconnect the power supply, and clean it with a half-wet soft cloth. If the machine is really dirty, scrub with a mild detergent.
- This appliance is not intended for use by persons (including children) with reduced physical, sensory or mental capabilities, or lack of experience and knowledge, unless they have been given supervision or instruction

concerning use of the appliance by a person responsible for their safety.
(Except for the humidifier with CE-MARKING)

- Children should be supervised to ensure that they do not play with the appliance. (Except for the humidifier with CE-MARKING)
- The appliance can be used by children aged from 8 years and above and persons with reduced physical, sensory or mental capabilities if they have been given supervision or instruction concerning use of the appliance in a safe way and understand the hazards involved. Children shall not play with the appliance. Cleaning and maintenance shall not be made by children without supervision(Only for the humidifier with CE-MARKING)
- If the supply cord is damaged, it must be replaced by the manufacturer, its service agent or similarly qualified persons in order to avoid a hazard.

Transportation, marking and storage for units

1. Transport of equipment containing flammable refrigerants
Compliance with the transport regulations
2. Marking of equipment using signs
Compliance with local regulations
3. Disposal of equipment using flammable refrigerants
Compliance with national regulations
4. Storage of equipment/appliances
The storage of equipment should be in accordance with the manufacturer's instructions.
5. Storage of packed (unsold) equipment
Storage package protection should be constructed such that mechanical damage to the equipment inside the package will not cause a leak of the refrigerant charge.

The maximum number of pieces of equipment permitted to be stored together will be determined by local regulations.

The appliance shall be stored so as to prevent mechanical damage from occurring

Remark:

The best operating ambient temperature is 5-35 ° C.

The fuse mode is 4T or 4F or 334 or L3CT, the specification is AC250V, 3.15A.

Appliance is filled with flammable gas R290, and the maximum charge of refrigerant is 90g. GWP value of R290 refrigerant is 3.

Any repairs you need, contact the nearest authorized Service Centre and strictly follow manufacturer's instruction only.

APPENDIX

1. Information on servicing

1) Checks to the area

Prior to beginning work on systems containing flammable refrigerants, safety checks are necessary to ensure that the risk of ignition is minimized. For repair to the refrigerating system, the following precautions shall be complied with prior to conducting work on the system.

2) Work procedure

Work shall be undertaken under a controlled procedure so as to minimize the risk of a flammable gas or vapor being present while the work is being performed.

3) General work area

All maintenance staff and others working in the local area shall be instructed on the nature of work being carried out. Work in confined spaces shall be avoided. The area around the workspace shall be sectioned off. Ensure that the conditions within the area have been made safe by control of flammable material.

4) Checking for presence of refrigerant

The area shall be checked with an appropriate refrigerant detector prior to and during work, to ensure the technician is aware of potentially flammable atmospheres. Ensure that the leak detection equipment being used is suitable for use with flammable refrigerants, i.e. non-sparking, adequately sealed or intrinsically safe.

5) Presence of fire extinguisher

If any hot work is to be conducted on the refrigeration equipment or any associated parts, appropriate fire extinguishing equipment shall be available to hand. Have a dry powder or CO₂ fire extinguisher adjacent to the charging area.

6) No ignition sources

No person carrying out work in relation to a refrigeration system which involves exposing any pipe work that contains or has contained flammable refrigerant shall use any sources of ignition in such a manner that it may lead to the risk of fire or explosion. All possible ignition sources, including cigarette smoking, should be kept sufficiently far away from the site of installation, repairing, removing and disposal, during which flammable refrigerant can possibly be released to the surrounding space.

Prior to work taking place, the area around the equipment is to be surveyed to make

sure that there are no flammable hazards or ignition risks. “No Smoking” signs shall be displayed.

7) Ventilated area

Ensure that the area is in the open or that it is adequately ventilated before breaking into the system or conducting any hot work. A degree of ventilation shall continue during the period that the work is carried out. The ventilation should safely disperse any released refrigerant and preferably expel it externally into the atmosphere.

8) Checks to the refrigeration equipment

Where electrical components are being changed, they shall be fit for the purpose and to the correct specification. At all times the manufacturer’s maintenance and service guidelines shall be followed. If in doubt consult the manufacturer’s technical department for assistance.

The following checks shall be applied to installations using flammable refrigerants:

- a) The charge size is in accordance with the room size within which the refrigerant containing parts are installed.
- b) The ventilation machinery and outlets are operating adequately and are not obstructed.
- c) If an indirect refrigerating circuit is being used, the secondary circuit shall be checked for the presence of refrigerant.
- d) Marking to the equipment continues to be visible and legible. Markings and signs that are illegible shall be corrected.
- e) Refrigeration pipe or components are installed in a position where they are unlikely to be exposed to any substance which may corrode refrigerant containing components, unless the components are constructed of materials which are inherently resistant to being corroded or are suitably protected against being so corroded.

9) Checks to electrical devices

Repair and maintenance to electrical components shall include initial safety checks and component inspection procedures. If a fault exists that could compromise safety, then no electrical supply shall be connected to the circuit until it is satisfactorily dealt with. If the fault cannot be corrected immediately but it is necessary to continue operation, an adequate temporary solution shall be used. This shall be reported to the owner of the equipment so all parties are advised.

Initial safety checks shall include:

- a) That capacitors are discharged: this shall be done in a safe manner to avoid possibility of sparking.
- b) That there no live electrical components and wiring are exposed while charging, recovering or purging the system.
- c) That there is continuity of earth bonding.

2. Repairs to sealed components

1) During repairs to sealed components, all electrical supplies shall be disconnected from the equipment being worked upon prior to any removal of sealed covers, etc. If it is absolutely necessary to have an electrical supply to equipment during servicing, then a permanently operating form of leak detection shall be located at the most critical point to warn of a potentially hazardous situation.

2) Particular attention shall be paid to the following to ensure that by working on electrical components, the casing is not altered in such a way that the level of protection is affected. This shall include damage to cables, excessive number of connections, terminals not made to original specification, damage to seals, incorrect fitting of glands, etc. Ensure that apparatus is mounted securely.

Ensure that seals or sealing materials have not degraded such that they no longer serve the purpose of preventing the ingress of flammable atmospheres.

Replacement parts shall be in accordance with the manufacturer's specifications.

NOTE: The use of silicon sealant may inhibit the effectiveness of some types of leak detection equipment. Intrinsically safe components do not have to be isolated prior to working on them.

3. Repair to intrinsically safe components

Do not apply any permanent inductive or capacitance loads to the circuit without ensuring that this will not exceed the permissible voltage and current permitted for the equipment in use.

Intrinsically safe components are the only types that can be worked on while live in the presence of a flammable atmosphere. The test apparatus shall be at the correct rating.

Replace components only with parts specified by the manufacturer. Other parts may result in the ignition of refrigerant in the atmosphere from a leak.

4. Cabling

Check that cabling will not be subject to wear, corrosion, excessive pressure, vibration, sharp edges or any other adverse environmental effects. The check shall also take into account the effects of aging or continual vibration from sources such as compressors or fans.

5. Detection of flammable refrigerants

Under no circumstances shall potential sources of ignition be used in the searching for or detection of refrigerant leaks. A halide torch (or any other detector using a naked flame) shall not be used.

6. Leak detection methods

The following leak detection methods are deemed acceptable for systems containing flammable refrigerants.

Electronic leak detectors shall be used to detect flammable refrigerants, but the sensitivity may not be adequate, or may need re-calibration. (Detection equipment shall be calibrated in a refrigerant-free area.) Ensure that the detector is not a potential source of ignition and is suitable for the refrigerant used. Leak detection equipment shall be set at a percentage of the LFL of the refrigerant and shall be calibrated to the refrigerant employed and the appropriate percentage of gas (25 % maximum) is confirmed.

Leak detection fluids are suitable for use with most refrigerants but the use of detergents containing chlorine shall be avoided as the chlorine may react with the refrigerant and corrode the copper pipe-work.

If a leak is suspected, all naked flames shall be removed/ extinguished.

If a leakage of refrigerant is found which requires brazing, all of the refrigerant shall be recovered from the system, or isolated (by means of shut off valves) in a part of the system remote from the leak. Oxygen free nitrogen (OFN) shall then be purged through the system both before and during the brazing process.

7. Removal and evacuation

When breaking into the refrigerant circuit to make repairs – or for any other purpose –conventional procedures shall be used. However, it is important that best practice is followed since flammability is a consideration. The following procedure shall be adhered to:

- 1) Remove refrigerant.
- 2) Purge the circuit with inert gas.
- 3) Evacuate.
- 4) Purge again with inert gas.
- 5) Open the circuit by cutting or brazing.

The refrigerant charge shall be recovered into the correct recovery cylinders. The system shall be “flushed” with OFN to render the unit safe. This process may need to be repeated several times. Compressed air or oxygen shall not be used for this task.

Flushing shall be achieved by breaking the vacuum in the system with OFN and continuing to fill until the working pressure is achieved, then venting to atmosphere, and finally pulling down to a vacuum. This process shall be repeated until no refrigerant is within the system. When the final OFN charge is used, the system shall be vented down to atmospheric pressure to enable work to take place. This operation is absolutely vital if brazing operations on the pipe-work are to take place.

Ensure that the outlet for the vacuum pump is not close to any ignition sources and there is ventilation available.

8. Charging procedures

In addition to conventional charging procedures, the following requirements shall be followed.

- 1) Ensure that contamination of different refrigerants does not occur when using charging equipment. Hoses or lines shall be as short as possible to minimize the amount of refrigerant contained in them.
- 2) Cylinders shall be kept upright.
- 3) Ensure that the refrigeration system is earthed prior to charging the system with refrigerant.
- 4) Label the system when charging is complete (if not already).
- 5) Extreme care shall be taken not to overfill the refrigeration system.

Prior to recharging the system it shall be pressure tested with OFN. The system shall be leak tested on completion of charging but prior to commissioning. A follow up leak test shall be carried out prior to leaving the site.

9. Decommissioning

Before carrying out this procedure, it is essential that the technician is completely familiar with the equipment and all its detail. It is recommended good practice that all

refrigerants are recovered safely. Prior to the task being carried out, an oil and refrigerant sample shall be taken in case analysis is required prior to re-use of reclaimed refrigerant. It is essential that electrical power is available before the task is commenced.

- 1) Become familiar with the equipment and its operation.
- 2) Isolate system electrically.
- 3) Before attempting the procedure ensure that:
 - a) Mechanical handling equipment is available, if required, for handling refrigerant cylinders.
 - b) All personal protective equipment is available and being used correctly.
 - c) The recovery process is supervised at all times by a competent person.
 - d) Recovery equipment and cylinders conform to the appropriate standards.
- 4) Pump down refrigerant system, if possible.
- 5) If a vacuum is not possible, make a manifold so that refrigerant can be removed from various parts of the system.
- 6) Make sure that cylinder is situated on the scales before recovery takes place.
- 7) Start the recovery machine and operate in accordance with manufacturer's instructions.
- 8) Do not overfill cylinders. (No more than 80 % volume liquid charge).
- 9) Do not exceed the maximum working pressure of the cylinder, even temporarily.
- 10) When the cylinders have been filled correctly and the process completed, make sure that the cylinders and the equipment are removed from site promptly and all isolation valves on the equipment are closed off.
- 11) Recovered refrigerant shall not be charged into another refrigeration system unless it has been cleaned and checked.

10. Labelling

Equipment shall be labelled stating that it has been de-commissioned and emptied of refrigerant. The label shall be dated and signed. Ensure that there are labels on the equipment stating the equipment contains flammable refrigerant.

11. Recovery

When removing refrigerant from a system, either for servicing or decommissioning, it is recommended good practice that all refrigerants are removed safely.

When transferring refrigerant into cylinders, ensure that only appropriate refrigerant

recovery cylinders are employed. Ensure that the correct number of cylinders for holding the total system charge is available. All cylinders to be used are designated for the recovered refrigerant and labelled for that refrigerant (i.e. special cylinders for the recovery of refrigerant). Cylinders shall be complete with pressure relief valve and associated shut-off valves in good working order. Empty recovery cylinders are evacuated and, if possible, cooled before recovery occurs.

The recovery equipment shall be in good working order with a set of instructions concerning the equipment that is at hand and shall be suitable for the recovery of flammable refrigerants. In addition, a set of calibrated weighing scales shall be available and in good working order. Hoses shall be complete with leak-free disconnect couplings and in good condition. Before using the recovery machine, check that it is in satisfactory working order, has been properly maintained and that any associated electrical components are sealed to prevent ignition in the event of a refrigerant release. Consult manufacturer if in doubt.

The recovered refrigerant shall be returned to the refrigerant supplier in the correct recovery cylinder, and the relevant Waste Transfer Note arranged. Do not mix refrigerants in recovery units and especially not in cylinders.

If compressors or compressor oils are to be removed, ensure that they have been evacuated to an acceptable level to make certain that flammable refrigerant does not remain within the lubricant. The evacuation process shall be carried out prior to returning the compressor to the suppliers. Only electric heating to the compressor body shall be employed to accelerate this process. When oil is drained from a system, it shall be carried out safely.



Correct Disposal of this product

This marking indicates that the product should not be disposed with other household wastes throughout the EU. To prevent possible harm to the environment or human health from uncontrolled waste disposal, recycle it responsibly to promote the sustainable reuse of material resources. To return your used device, please use the return and collection systems or contact the retailer where the product was purchased. They can take this product for environmentally safe recycling.